

# Fuses

from 3.6 to 36 kV

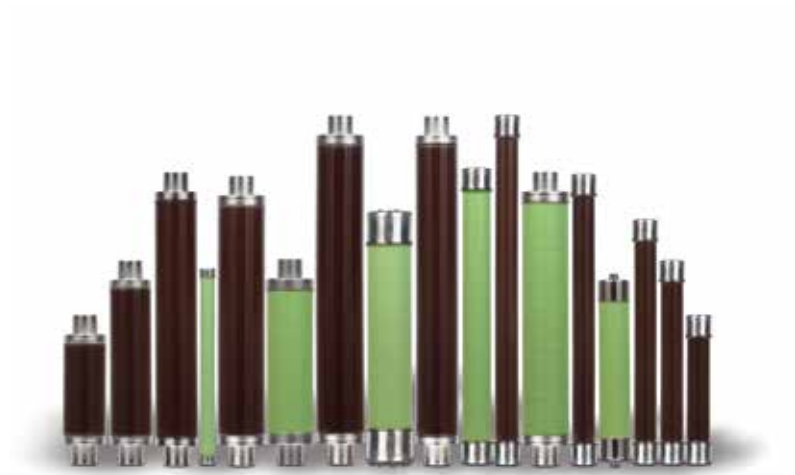

# Your requirements



Quality



High  
capabilities



More than 10.000.000

# Our proposal

## Compliance with latest international and local standards

- Complete type test certificates: CESI, LES RENARDIERES, LABEIN, etc

## Certified manufacturing process

- Process controlled under the quality standard ISO 9001 and ISO 14001
- Regular main electrical company's audits (EDF, IBERDROLA, SONELGAZ,...)

## Trustworthy partner

- Among the largest manufacturers of M.V. Fuses all over the world with references in over 110 countries

## A full range of fuses with up-to-date technology

- High rupture capacity
- Low switching overvoltage
- Low values of  $I_3$  (minimum breaking current)
- Low electrical losses caused by heat disipation
- With thermal striker for the signaling and the trigger
- Outdoor use
- Thermal striker, medium type into the Fusarc fuses



fuses sold in the world



“Fuses are the one of the first device to ensure the protection of your equipment and your installations.

That must be taken into account when thinking of continuity of service for your activity.”

# Services

## Peace of mind throughout your installation life cycle

How can you cut costs and improve performance at the same time?

When it comes to your electrical distribution infrastructure, the answer is straight forward - get professional expertise.



### Plan

Schneider Electric helps you to plan the full design and execution of your solution, looking at securing your process and optimising your time:

**Technical feasibility studies:** Accompany customer to design solution in his given environment.

**Preliminary design:** Accelerate turn around time to come to a final solution design.

### Install

Schneider Electric will help you to install efficient, reliable and safe solutions based on your plans.

**Project Management:** Designed to help you complete your projects on time and within budget.

**Commissioning:** Ensures your actual performance versus design, through on site testing & commissioning, tools & procedures.

### Operate

Schneider Electric helps you maximise your installation uptime and control your capital expenditures through its services offering.

**Asset Operation Solutions:** The information you need to increase safety, enhance installation training performance, and optimise asset maintenance and investment.

**Advantage Service Plans:** Customised services plans which cover preventive, predictive and corrective maintenance.

**On site Maintenance services:** Extensive knowledge and experience in electrical distribution maintenance. For Diagnosis services see on pages from F1 to F3.

**Spare parts management:** Ensure spare parts availability and optimised maintenance budget of your spare parts.

**Technical Training:** To build up necessary skills and competencies. in order to properly operate your installations in safety.



When it comes to your electrical distribution installation, we can help you:

- Increase productivity, reliability, and safety
- Mitigate risk and limit downtime
- Keep equipment up to date and extend lifespan
- Cut cost and increase savings
- Improve your return on investment

**CONTACT US!**

**[www.schneider-electric/electricaldistributionservices](http://www.schneider-electric/electricaldistributionservices)**

### Optimise

Schneider Electric propose recommendations for improved safety, availability, reliability & quality.

**MP4 Electrical Assessment:** Define improvement & risk management program.

### Renew

Schneider Electric extends the life of your system while providing upgrades. Schneider Electric offers to take full responsibility for the end-of-life processing of old electrical equipments.

**ECOFIT™:** Keep up to date & improve performances of your electrical installations (LV,MV, Protection Relays...).

**MV product End of life:** recycle & recover outdated equipment with end of life services.

# ProDiag Fuse

## Schneider Electric proprietary and standard diagnostic tools



### Customer needs

Electrical power installations protected by MV switchgear with fuse protection should be regularly checked (for correct assembly, electrical parameters, etc.) to confirm that their characteristics correspond to the original specification. Regular diagnosis of fuse performance (electrical parameters, resistance) according to the manufacturer's recommendations is necessary to secure the ED installation and its service continuity, which are important for customers.

The ProDiag Fuse diagnostic solution can be used on MV switchgear protected by fuses that have not received any maintenance intervention in the last four years (under normal operating conditions, and less if operating in severe environments or depending on their criticality in the installation).

The purpose of ProDiag Fuse (a proprietary hardware-software solution) is to mitigate the risks on MV switchgear and equipment by fuses of faults or drifts causing unwanted effects. The result of fuse premature ageing caused by thermal or electrical over-stressing of the high-voltage system is the destruction of filaments that can lead to thermal runaway, partial damage, complete destruction of MV switchgear and equipment, or even destruction of the electrical room.



### Customer benefits

ProDiag Fuse helps customers visualise, discover, and understand MV switchgear fuse ageing and wear and tear as compared to the original fuse manufacturers' technical specification.

ProDiag Fuse monitors the performance of MV switchgear fuses. Thanks to ProDiag Fuse, maintenance managers can implement, manage, and enrich their maintenance plans. Schneider Electric FSRs conclude their on-site interventions with an exhaustive report on the MV switchgear fuses conformity/non-conformity. If a MV fuse is declared non-conforming, Schneider Electric suggests a corrective plan that includes fuse replacement to regain original performance in safety and service continuity.

Customers can augment their preventive maintenance plans with this corrective action at the most convenient time for each ED device.

### "Unique value for customer vs standard market tools"

Electrical parameter measurements (resistance, etc.) on MV switchgear fuses at customer sites are taken by a test tool and transmitted to the Schneider Electric FSRs' ProDiag Fuse software. Data are compared to those of a fuse manufacturers' technical database.

The aim is to determine whether recorded measurements are within the acceptable range, at the limit, or fall outside it, as criteria for MV switchgear fuse conformity.

As an ED equipment manufacturer, Schneider Electric is uniquely positioned to develop and invest in specific tests tools, proprietary software, and testing methodology to collect reliable measurements from MV switchgear fuses.

ProDiag Fuse measures a larger number of parameters than standard market tools. It delivers best-in-class MV switchgear fuse diagnostics.

Schneider Electric scope: Schneider Electric fuses and main market fuses players.



Public distribution

Our Fusarc CF, Soléfuse, Tépéfuse and MGK fuses make up a broad, consistent and uniform range of high breaking capacity fuses and current limitors.

They are all of combined type and are manufactured so that they can be installed both indoors and outdoors (depending on the type).

**Schneider Electric fuses provide protection to medium voltage distribution devices** (from 3 to 36 kV) from both the dynamic and thermal effects of shortcircuit currents greater than the fuse's minimum breaking current.

Considering their low cost and their lack of required maintenance, medium voltage fuses are an excellent solution to protect various types of distribution devices:

- Medium voltage current consumers (transformers, motors, capacitors, etc.)
- Public and industrial electrical distribution networks.

They offer dependable protection against major faults that can occur either on medium or low voltage circuits.

This protection can be further enhanced by combining the fuses with low voltage protection systems or with an overcurrent relay.

## Applications

- Motors
- Power Transformers
- Capacitors
- Voltage Transformers

## References

Our fuses are installed in over 110 countries, overall MV segments, mainly: Utilities, Renewable Industry, Railways, Mining, Oil & Gas and Big Industry.

The major utilities put their trust in our products and protect their equipments using our fuses:

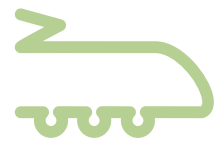
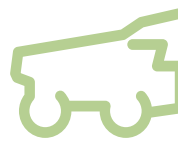

Algeria	CAMEG, SONELGAZ, EDIEL, AL-ELEC...
Argentina	EDESUR, EDENOR
Australia	
Belgium	ELECTRABEL
Brazil	
Chili	CHILECTRA
China	
Colombia	CODENSA
Czech Republic	
Denmark	
Dubai	
Egypt	R.E.A.
France	EDP
Germany	
Greece	PPC
Hong-Kong	
Hungary	

Italy	ENEL
Ireland	ESB
Indonesia	PLN
Korea	
Malaysia	
Mexico	CFE
Morocco	ONE
New Zealand	
Norway	
Peru	EDELNOR
Poland	
Portugal	EDP
Romania	
Russia	
Rwanda	

Saudi Arabia	
Singapore	
Slovakia	
South Africa	ESKOM
Spain	IBERDROLA, ENDESA, UNION FENOSA, HIDROCANTÁBRICO
Sweden	
Switzerland	
Taiwan	
Thailand	PEA/MEA
Tunisia	STEG
Turkey	TEDAS
United Arab Emirates	
United Kingdom	
Union Fenosa	
Uruguay	U.T.E.
Venezuela	
Vietnam	EVN



PE56266

PE5711



## Quality assurance system

In addition to being tested in our own laboratories as well as in official laboratories such as the CESI, Les Renardières and Labein, with their own respective certificates, our fuses are manufactured according to quality guidelines within the framework of the ISO 9001 and ISO 14001 Quality System Certification awarded by AENOR (IQ-NET) which provides an additional guarantee for Schneider Electric products.

## Routine testing

During manufacture, each fuse is subject to systematic routine testing, with the aim of checking its quality and conformity:

- Dimensional control and weight control
- Visual control of markings, labelling and external appearance
- Electrical resistance measurement: a key point to ensure that fuses have the required performance levels at the end of the production process and to check that no damage has occurred during assembly.

Measurement of the room temperature resistance of each fuse is therefore carried out in order to check that they are in line with values, according to their rated voltage and rated current.

## A major asset : Certified quality ISO 9001 and ISO 14001

Schneider Electric has a functional organisation whose main mission is to check quality and monitor compliance with standards in each of its production units.

MESA, the only company in Schneider Electric that makes fuses, is certified by AENOR (The Spanish Standards Association), and is certified to ISO 9001.

The environmental management system adopted by Schneider Electric's production sites has been assessed and recognized as conforming to the requirements of the ISO 14001 standard.

Furthermore, Schneider Electric annually carries out internal type-testing and breaking testing in order to comply with our annual quality assurance plan, which is available on request to our customers.

## Seal testing

In order to test the sealing of our Fusarc CF fuses, they are immersed for 5 minutes in a hot water bath (80°C), in accordance with standard IEC 60282-1.

## Standards

Our fuses are designed and manufactured according to the following standards:

- IEC 60282-1, IEC 60787 (Fusarc CF, Soléfuse, Tépéfuse, MGK)
- DIN 43625 (Fusarc CF)
- VDE 0670-402 (Fusarc CF)
- UTE C64200, C64210 (Soléfuse, Tépéfuse)





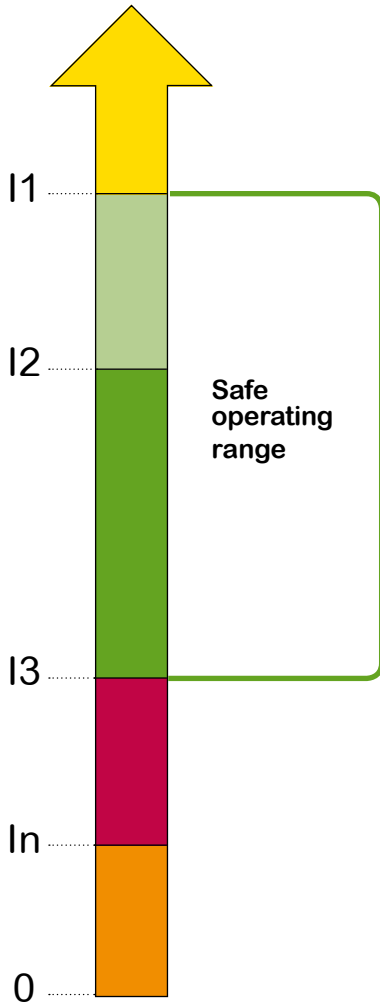

Definition of a fuse's operating zone (operating ranges of combined type fuses).

## Key definitions

### I1: maximum rated breaking current

This is the presumed fault current that the fuse can interrupt. This value is very high for our fuses ranging from 20 to 63 kA.

**Comment:** it is necessary to ensure that the network short circuit current is at least equal to the I1 current of the fuse that is used.

### I2: critical currents (currents giving similar conditions to the maximum arcing energy).

This current subjects the fuse to greater thermal and mechanical stresses.

The value of I2 varies between 20 and 100 times the In value, depending on the design of the fuse element. If the fuse can break this current, it can also break currents between I3 and I1.

### I3: minimum rated breaking current

This is the minimum current value which causes the fuse to blow and break the current. For our fuses, these values are between 3 and 5 times the In value.

**Comment:** it is not enough for a fuse to blow in order to interrupt the flow of current. For current values less than I3, the fuse will blow, but may not break the current. Arcing continues until an external event interrupts the current. It is therefore essential to avoid using a fuse in the range between In and I3.

Overcurrents in this range may irreversibly damage fuse elements, whilst still maintaining the risk of an arc which is not broken, and of them being destroyed.

### In: rated current

This is the current value that the fuse can withstand on a constant basis without any abnormal temperature rise (generally 65 Kelvin for the contacts).

### Un: rated voltage

This is the highest voltage between phases (expressed in kV) for the network on which the fuse might be installed.

**In the medium voltage range, the preferred rated voltages have been set at: 3.6 - 7.2 - 12 - 17.5 - 24 and 36 kV.**

## Description

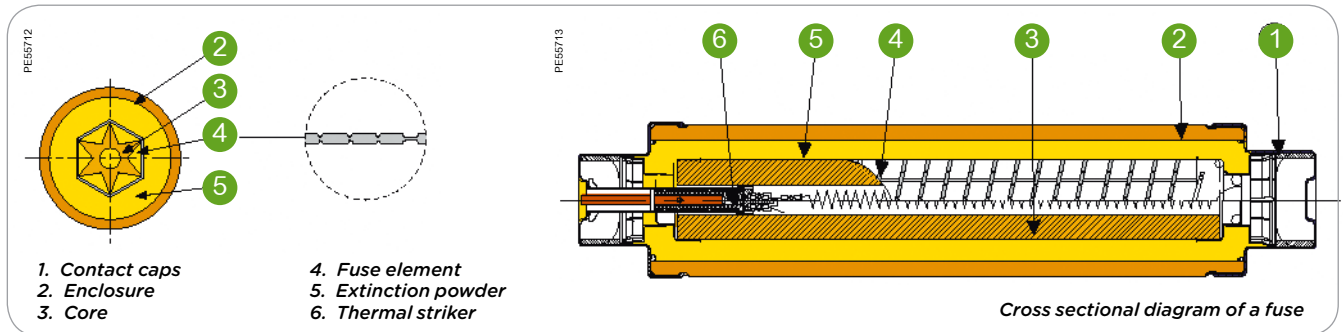

### 1 End contact caps

Together with the enclosure, they form an assembly which must remain intact before, during and after breaking the current. This is why they have to withstand mechanical stresses and sealing stresses due to overpressure caused by arcing. The stability of the internal components must also be ensured over time.

### 2 Enclosure

This part of the fuse must withstand certain specific stresses (related to what has already been mentioned):

Thermal stresses: the enclosure has to withstand the rapid temperature rise that occurs when the arc is extinguished

Electrical stresses: the enclosure has to withstand the restoring of current after breaking

Mechanical stresses: the enclosure has to withstand the increase in pressure caused by the expansion of the sand when breaking occurs.

### 3 Core

This is a cylinder surrounded by ceramic fins onto which the fuse element is wound.

The striker control wire together with the latter are fitted in the cylinder. They are insulated from the fuse elements.

### 4 Fuse element

This is the main component of the fuse. It is made from materials with very low resistance and which do not wear over time. Our fuse elements are carefully configured following a lot of testing, to enable us to achieve the required results.

### 5 Extinction powder

The extinction powder is made up of high purity quartzite sand (over 99.7%), which is free from any metal compounds and moisture.

When it vitrifies, the sand absorbs the energy produced by the arc and forms an insulating compound called fulgurite with the fuse element.

### 6 Thermal striker

This is a mechanical device which indicates correct fuse operation. It also provides the energy required to actuate a combined breaking device.

The striker is controlled by a heavy duty wire which, once the fuse element has blown, also melts and releases the striker. It is very important that the control wire does not cause premature tripping of the striker, nor must it interfere with the breaking process.

The Schneider Electric limiting fuse, with its thermal striker, is not only capable of indicating and breaking short circuits. It is also capable of this for prolonged overcurrents, and currents causing significant temperature rises in the devices combined with the fuses and the fuses themselves.

The thermal strikers installed in our fuses are of "medium type" and their force/travel characteristics (approximately 1 joule according to standard IEC-60282-1) are shown in the figure below:

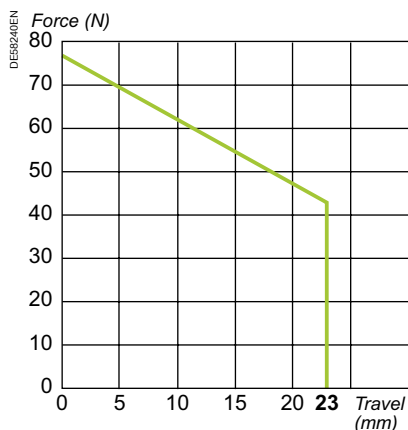

Value of the force provided by the striker according to its length of travel.

The most significant features provided by our range of fuses are as follows:

- High breaking capacity
- High current limitation
- Low I2t values
- Dependable breaking of critical currents
- Low breaking overvoltage
- Low dissipated power
- No maintenance or ageing
- For indoor and outdoor applications
- With a thermal striker
- Low minimum breaking current values.

## Selection table

Depending on the equipment to be protected and its voltage rating, the table below gives the range of fuses which are best suited to the protection application.

Voltage (kV)	Motors	Power transformers	Capacitors	Voltage transformers
3.6	Fusarc CF MGK	Fusarc CF	Fusarc CF	Fusarc CF
7.2	Fusarc CF MGK	Fusarc CF Soléfuse	Fusarc CF Soléfuse	Fusarc CF
12	Fusarc CF	Fusarc CF Soléfuse	Fusarc CF Soléfuse	Tépéfuse Fusarc CF
17.5		Fusarc CF Soléfuse	Fusarc CF Soléfuse	Tépéfuse Fusarc CF
24		Fusarc CF	Fusarc CF Soléfuse	Tépéfuse Fusarc CF Soléfuse
36		Fusarc CF Soléfuse	Fusarc CF Soléfuse	Tépéfuse Fusarc CF

**Soléfuse**  
(UTE standard;  
transformer protection)

**MGK**  
(UTE standard;  
motor protection)

**Fusarc CF**  
(DIN standard;  
transformer, motor and  
capacitor protection)

**Tépéfuse**  
(UTE standard;  
voltage transformer protection)



# Fusarc CF

## MV limiting fuses with thermal striker

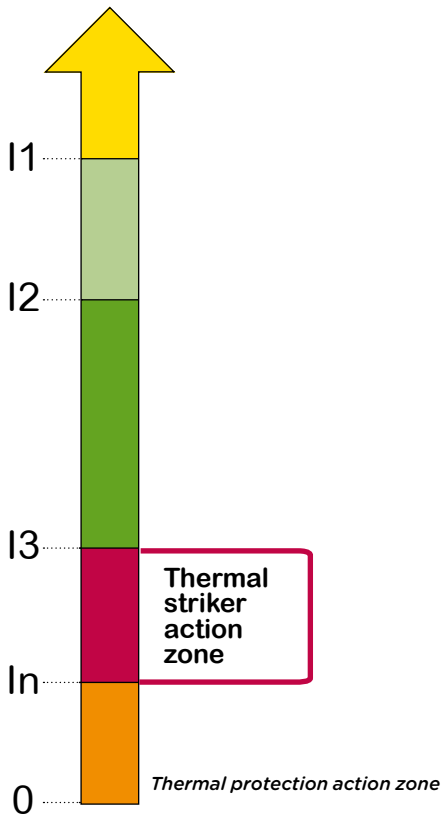

All Schneider Electric fuses type Fusarc CF are provided of a thermal protection device. In the case of permanent overcurrents lower than  $I_3$  and superior to the rated current ( $I_n$ ), the fuse mechanical striker acts opening the device associated and avoiding any incidents due to overheatings.

In this way, the fuse not only works as a current limiter but also as a temperature limiter when combined with an external breaking device.

These types of fuses, which integrate a thermal striker, are fully compatible with standard Back UP type fuses.

### Technical / economic / safety advantages:

The use of a thermal protector in our fuses provides the following advantages:

- Protecting the fuses and their environment from unacceptable temperature rises in installations equipped with a disconnecting switch with the possibility of automatic opening
- Providing a response to unexpected operating conditions, to frequent or longlasting overloads, or to mistakes in selecting the fuse rating, or even concerning restricted ventilation conditions within the installation
- Indicating and protecting against overloads caused by overcurrents below the minimum breaking current ( $I_3$ ) of the installed fuse and which can cause dangerous operating temperatures
- Reducing operating costs due to destruction of equipment or excess costs caused by loss of quality of service (repair time, staff, etc.).

This thermal protector safety feature, significantly reduces the risk of damage and accidents in installations and therefore increases the power distribution quality of service.

The characteristics of the thermal striker fuse (breaking capacity, fuse curves, limiting values, striker force, etc.) do not vary relative to our fuses without thermal protection.



SM6 switchgear

# Fusarc CF

## Characteristics and dimensions

PE40483\_NE\_IG1



RM6 RMU with CF fuses

PM103171



### Fusarc CF

This is Schneider Electric's DIN standard fuse range. When designing this range, we paid particular attention to minimise power dissipation.

It is increasingly common to use RMU units with SF6 gas as the insulating material. In view of these operating conditions, in which the fuse is inserted inside a hermetically sealed fuse chamber, with virtually no ventilation, these fuses avoid premature ageing of themselves and of the whole device which would otherwise be caused by a non-optimised fuse.

The enclosure in the Fusarc CF range up to 100 A (rated current) is made from crystallised brown porcelain which withstands ultra-violet radiation and can therefore be installed both outdoors and indoors.

Fuses with rated current values greater than 100 A have glass fibre enclosures and are only for indoor installations.

You will find the full list of the Fusarc CF range in the table given on the following page. With rated voltages ranging from 3 to 36 kV and rated currents of up to 250 A, they meet customers' exact requirements in terms of switchgear short-circuit protection.

### Time/current fuse curves

These curves show the virtual fusion or pre-arcing time, as a function of the value of the symmetrical component of the intended current. Careful selection and design of fuse elements, together with meticulous industrial control, provides Schneider Electric customers with precise time-current curves, well above the tolerance limits provided for in standard IEC 60282-1.

When designing our Fusarc CF fuses, we focused on a relatively high fusion current at 0.1 s in order to withstand transformer making currents and at the same time a low fusion current at 10 s in order to achieve quick breaking in the case of a fault.

On page 21, we give the time/current characteristics of Fusarc CF fuses.

### Current limitation curves

Schneider Electric fuses are current limiting. Consequently, short circuit currents are limited without reaching their maximum value. These diagrams show the relationship between the presumed short-circuit current and the peak value of the current broken by the fuse. The intersection of these lines with straight lines for I<sub>max</sub> symmetrical and I<sub>max</sub> asymmetrical give the presumed breaking current, below which fuses no longer have their limiting capacity.

For example, as shown in the limitation curves on page 10, for a short-circuit whose presumed current is 5 kA, in an unprotected installation, the maximum current value would be 7 kA for symmetrical flow and 13 kA for an asymmetrical case.

If we had used a Fusarc CF fuse with a rated current of 16 A, the maximum value reached would have been 1.5 kA.

### Dimensions (mm)

Figure 4

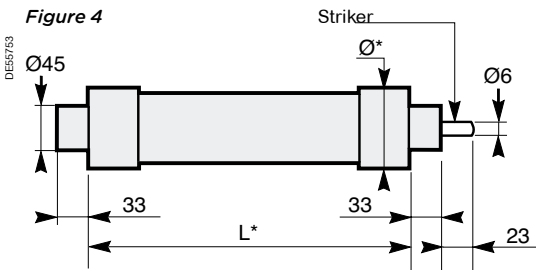

\* The following page gives the diameter and length of the fuse according to its rating.

# Fusarc CF

## References and characteristics

Reference	Rated voltage (kV)	Operating voltage (kV)	Rated current (A)	Max. breaking current I <sub>1</sub> (kA)	Min. breaking current I <sub>3</sub> (A)	Cold resistance* (mΩ)	Dissipated power (W)	Length (mm)	Diameter (mm)	Weight (kg)						
757372AR**	3,6	3/3,6	250	50	2000	0,67	58	292	86	3,4						
51311006M0	7,2	3/7,2	4	63	20	796	20	192	50,5	1						
51006500M0			6,3		36	186,4	12									
51006501M0			10		39	110,5	14									
51006502M0			16		50	68,5	26									
51006503M0			20		62	53,5	32									
51006504M0			25		91	36,4	35									
51006505M0			31,5		106	26	42									
51006506M0			40		150	18	46									
51006507M0			50		180	12,4	44									
51006508M0			63		265	9,9	52									
51006509M0	80	280	7,4	68												
51006510M0	100	380	6,2	85												
51100049MB	7,2	3/7,2	6,3	63	36	186,4	12	292	50,5	1,2						
51100049MC			10		39	110,5	14									
51100049MD			16		50	68,5	26									
51100049ME			20		62	53,5	32									
51100049MF			25		91	36,47	35									
51100049MG			31,5		106	26,05	42									
51100049MH			40		150	18,06	46									
51100049MJ			50		180	12,46	44									
51100049MK			63		265	9,9	52									
51100049ML			80		280	7,4	68									
51100049MM	100	380	6,2	85												
757352BN	7,2	3/7,2	125	50	650	3,55	88	292	86	3,4						
757352BP**			160		1000	2,28	87									
757352BQ**			200		1400	1,8	95									
757374BR**			250		2200	0,966	95									
51311007M0	12	6/12	4	63	20	1177	27	292	50,5	1,2						
51006511M0			6,3		36	283,4	16									
51006512M0			10		39	165,5	18									
51006513M0			16		50	106	37									
51006514M0			20		62	82	42									
51006515M0			25		91	56	52									
51006516M0			31,5		106	40	59									
51006517M0			40		150	28	74									
51006518M0			50		180	18,5	70									
51006519M0			63		265	14,8	82									
51006520M0	80	280	11,1	102												
51006521M0	100	380	8,9	120												
757364CN**	12	6/12	125	40	650	5,3	143	442	86	5						
757354CP**			160		1000	3,5	127									
757354CQ**			200		1400	2,77	172									
51006522M0	17,5	10/17,5	10	40	39	212,2	23	292	50,5	1,2						
51006523M0			16		50	132	47									
51006524M0			25		91	71	72									
51006525M0			31,5		106	51	78									
51006526M0			40		150	35	90									
51311008M0			17,5		10/17,5	4	40				20	1487	34	367	50,5	1,5
51006527M0						6,3					36	369,3	21			
51006528M0						10					39	212,2	25			
51006529M0						16					50	132	46			
51006530M0						20					62	103	52			
51006531M0	25	91		71		66										
51006532M0	31,5	106		51		74										
51006533M0	40	150		35		94										
51006534M0	50	180		23,4		93										
51006535M0	63	265		19,4		121										
51006536M0	80	330	13,5	145												
51006537M0	100	450	11	192												

\* Resistances are given at  $\pm 10\%$  for a temperature of 20°C.

\*\* Fuses >100A rated current, are manufactured in glass fibre (for indoor use).

For fuses without thermal stricker, please contact the Sales Department.



# Fusarc CF

## References and characteristics

(cont.)

Reference	Rated voltage (kV)	Operating voltage (kV)	Rated current (A)	Max. breaking current I1 (kA)	Min. breaking current I3 (A)	Cold resistance* (mΩ)	Dissipated power (W)	Length (mm)	Diameter (mm)	Weight (kg)			
51108915M0	24	10/24	6.3	31.5	38	455	26	292	50.5	1.2			
51108916M0			10		40	257.3	35						
51108917M0			16		60	158	64						
51108918M0			20		73	123	84						
51108919M0			25		100	88	79						
51108920M0			31.5		112	61	90						
51108921M0			40		164	45	120						
51108922M0			50		233	33,55	157						
51108923M0			63		247	22,6	177						
51108807M0			6.3		40	36	455				26	367	50.5
51108808M0			16	50		158	58						
51108813M0			20	62		123	67						
51108814M0			25	91		88	76						
51108809M0			31.5	106		61	93						
51108810M0			40	150		44.5	115						
51311009M0			4	20		1505	34	442	50.5	1.7			
51006538M0			6.3	36		455	25						
51006539M0			10	39		257.5	31						
51006540M0			16	50		158	58						
51006541M0			20	62	123	67							
51006542M0	25	91	88	79									
51006543M0	31.5	106	61	96									
51006544M0	40	150	44.5	119									
51006545M0	50	31.5	180	33.6	136	76	4.5						
51006546M0	63		265	25.2	144								
51006547M0	80		330	18	200								
51006548M0	100		450	13.5	240								
51311010M0	36	20/36	4	20	20	2209	51	537	50.5	1.9			
51006549M0			6.3	36	714	39							
51006550M0			10	39	392.2	50							
51006551M0			16	50	252	98							
51006552M0			20	62	197	120							
51006553M0			25	91	133	133							
51006554M0			31.5	20	106	103	171				76	5.4	
51006555M0			40		150	70	207						
51006556M0			50	200	47	198	86				6.5		
51006557M0			63	250	35	240							

\* Resistances are given at  $\pm 10\%$  for a temperature of 20°C.

For fuses without thermal stricker, please contact the Sales Department.

### Time/current characteristics curves

3.6 - 7.2 - 12 - 17.5 - 24 - 36 kV

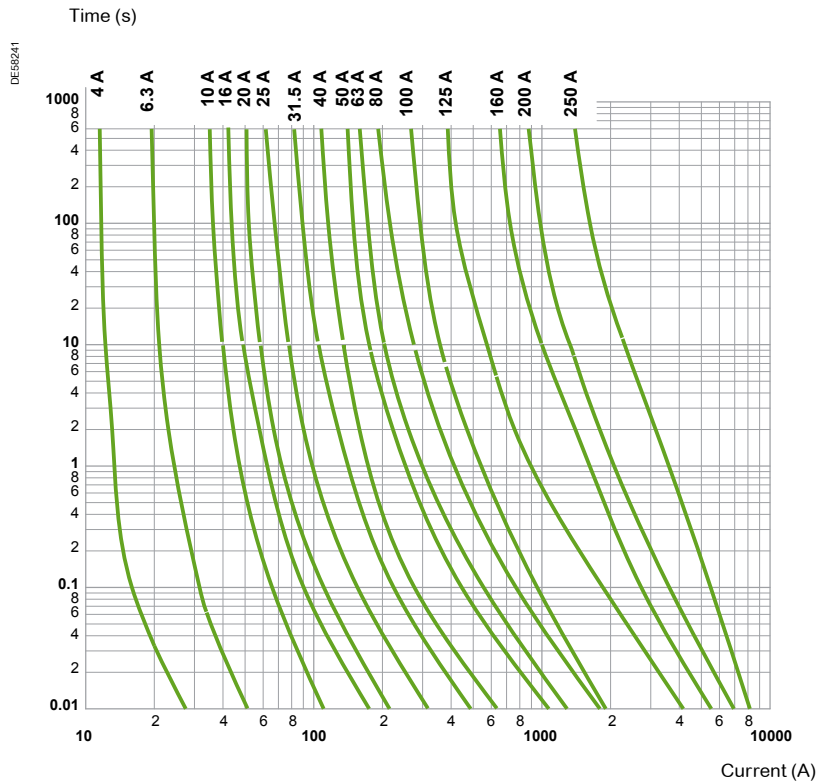

### Current limitation curves

3.6 - 7.2 - 12 - 17.5 - 24 - 36 kV

#### Maximum value of cut-off current (kA peak)

The diagram shows the maximum limited broken current value as a function of the rms current value which could have occurred in the absence of a fuse.

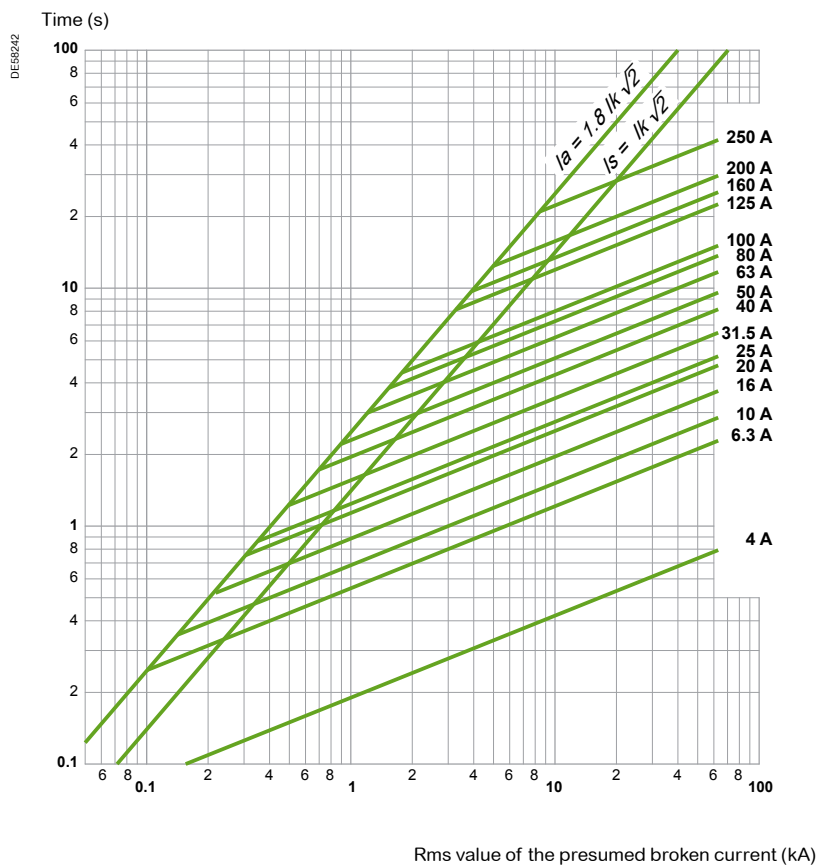

# Soléfuse

## References and characteristics

(cont.)

The Soléfuse range of fuses is manufactured according to UTE standard C64200. The rated voltage varies from 7.2 to 36 kV. They can be supplied with or without a striker and their weight is of around 2 kg. They are mainly intended to protect power transformers and distribution networks, and are solely for indoor installations (glass fibre enclosure).

### Electrical characteristics

Reference	Rated voltage (kV)	Operating voltage (kV)	Rated current (A)	Min. breaking current $I_3$ (A)	Max. breaking current $I_1$ (kA)	Cold resistance * (mΩ)	Power Dissipation values (W)
757328 BC	7,2	3/7,2	6,3	35	50	192,7	11
757328 BE			16	80		59,3	23
757328 BH			31,5	157,5		24,5	49
757328 BJ			43	215		16,15	59
757328 BK			63	315		11,3	84
757328 BN			125	625		4,8	140
757328 CM	7,2/12	3/12	100	500	50	7,7	143
757328 DL	7,2/17,5	3/17,5	80	400	40	15,1	180
757328 EC	12/24	10/24	6,3	35	31,5	454,3	30
757328 ED			10	50		241,9	31
757328 EE			16	80		117,3	41
757328 EG			25	125		69,1	58
757328 EH			31,5	157,5		45,77	81
757328 EJ			43	215		33,6	128
757328 EL			50	250		37	156
757328 EK			63	315		19,9	147
757331 GC**	12/24	10/24	6,3	35	31,5	463	35
757331 GD**			10	50		244,6	31
757331 GE**			16	80		118	41
757331 GG**			25	125		69,3	58
757331 GH**			31,5	157,5		46,2	81
757331 GJ**			43	215		34,3	128
757331 GL**			50	250		37	156
757331 GK**			63	315		19,9	150
757328 FC	36	30/36	6,3	35	20	762,6	42
757328 FD			10	50		252,9	43
757328 FE			16	80		207,8	92
757328 FF			20	100		133,2	93
757328 FG			25	125		124	136
757328 FH			31,5	157,5		93	172

\* Resistances are given at  $\pm 10\%$  for a temperature of 20°C.

\*\* Without striker.

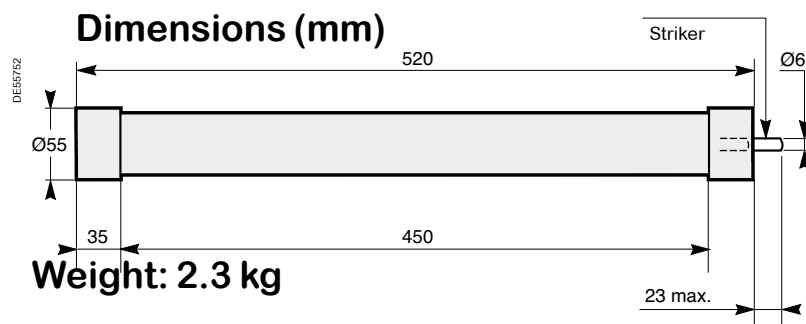

Weight: 2.3 kg



### Time/current characteristic curves

7.2 - 12 - 17.5 - 24 - 36 kV

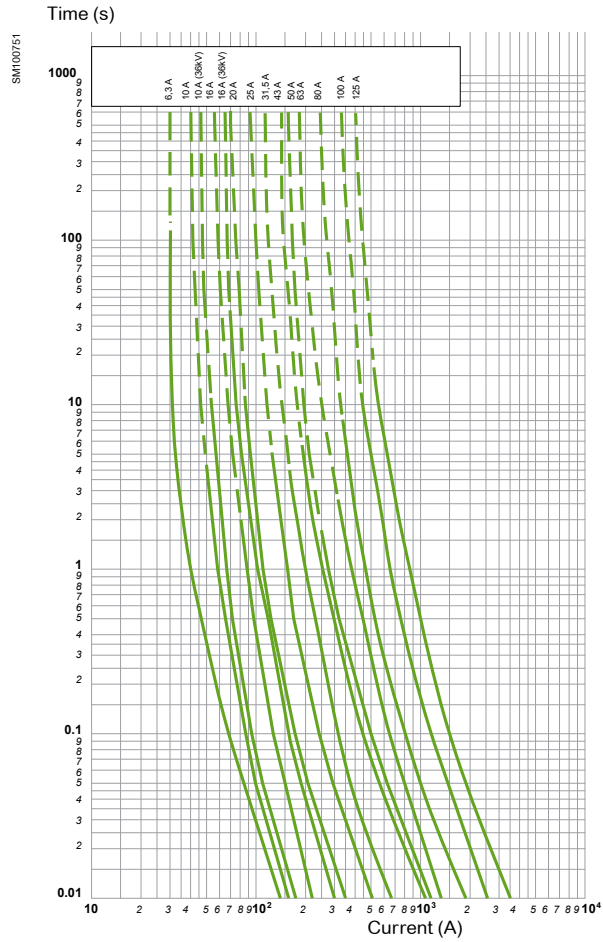

### Current limitation curves

7.2 - 12 - 17.5 - 24 - 36 kV

#### Maximum value of cut-off current (kA peak)

The diagram shows the maximum limited broken current value as a function of the rms current value which could have occurred in the absence of a fuse.

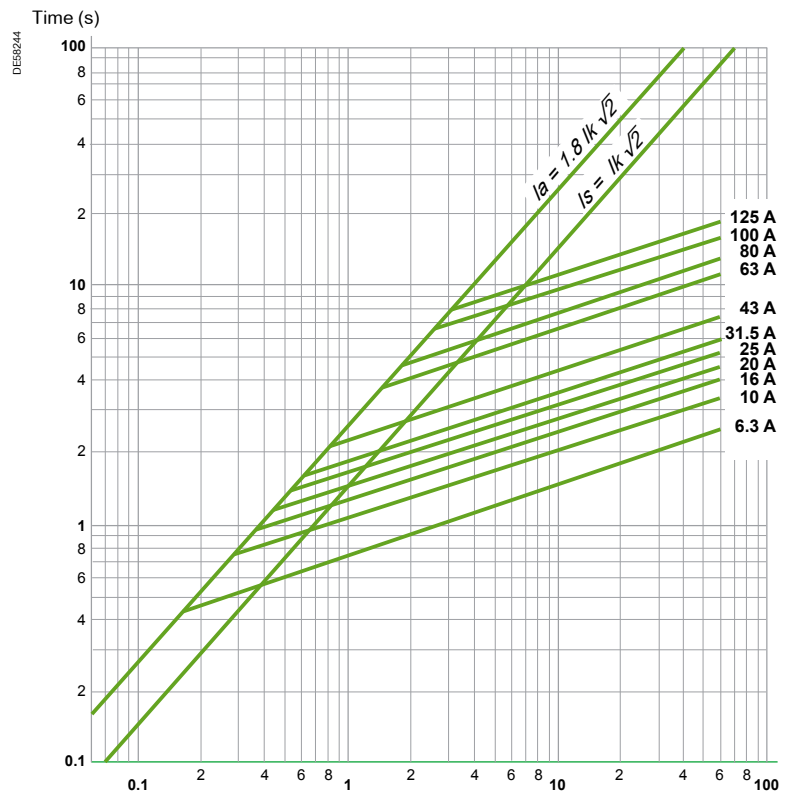

Rms value of the presumed broken current (kA)

# Tépéfuse and Fusarc CF

## Metering transformer protection

We manufacture Tépéfuse and Fusarc CF type fuses intended for metering transformer protection which have the following references and characteristics:

### Characteristics

Type	Reference	Rated voltage (kV)	Operating voltage (kV)	Rated current (A)	Max. breaking current I1 (kA)	Min. breaking current I3 (A)	Cold resistance* (mΩ)	Length (mm)	Diameter (mm)	Weight (kg)
Tépéfuse	781825A	12	< 12	0.3	40	40	6100	301	27.5	0.4
	781825B	24	13.8/24				11600			
Fusarc CF	51311002M0	7.2	3/7.2	2.5	63	9.5	1278	192	50.5	0.9
	51311000M0	12	6/12	1			3834			
	51311003M0			2.5			1917	292		
	51311011M0	17.5	10/17.5	2.5	2407	367	1.5			
	51311001M0	24	10/24	1	4815	442	1.6			
	51311004M0			2.5	2407					
	51311005M0	36	20/36	2.5	20	3537	537	1.8		

\* Resistances are given at ±10% for a temperature of 20°C.

Tépéfuse fuses are only made in glass fibre when intended for indoor usage.

Fuses for metering transformer protection are made without strikers, according to figures 6 and 7.

### Dimensions (mm)

#### Fusarc CF

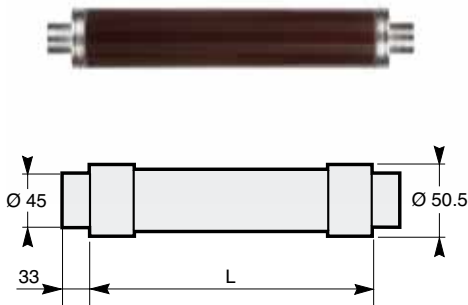

#### Tépéfuse

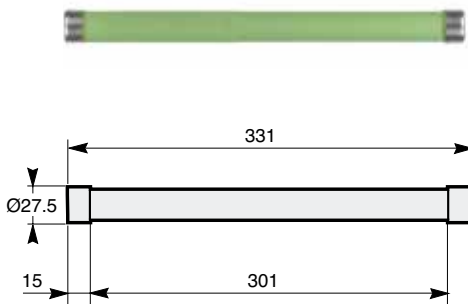

### Fuse curve 7.2 - 12 - 24 - 36 kV

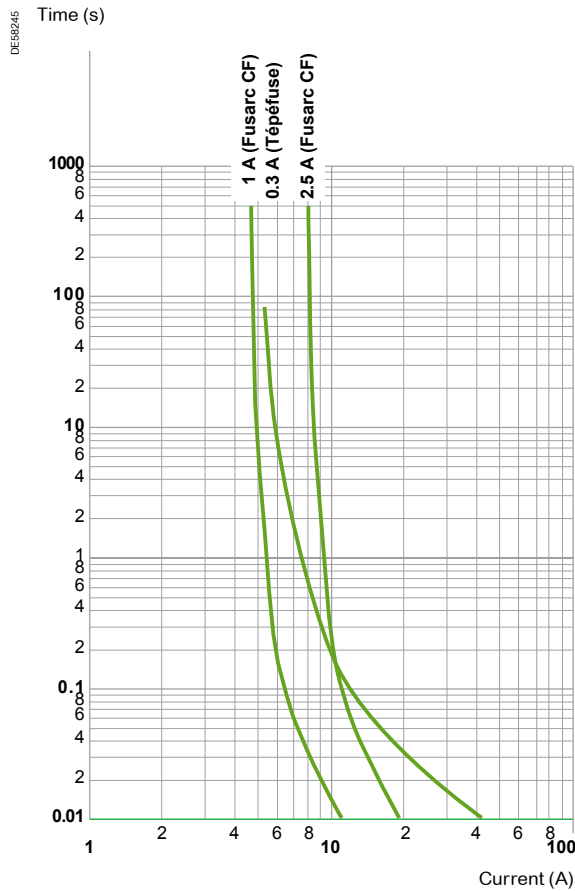

## Electrical characteristics

Reference	757314	757315	757316	757317	757318
Rated voltage	7.2 kV				
Operating voltage	≤ 7.2 kV				
Rated current (A)	100	125	160	200	250
Min. breaking current I <sub>3</sub> (A)	360	570	900	1400	2200
Max. breaking current I <sub>1</sub> (kA)	50				
Cold resistance * (mΩ)	6.4	4.6	2.4	1.53	0.98

\* Resistances are given at ±10% or a temperature of 20°C.

## Dimensions (mm)

PM103173



DE5761

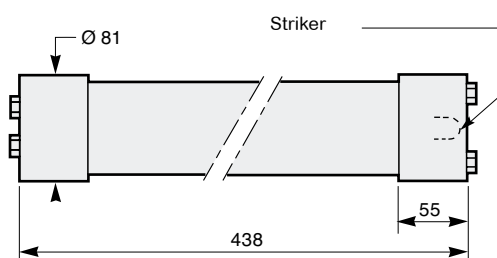

Weight: 4.1 kg

MGK fuses are intended to protect medium voltage motors at 7.2 kV (indoor application).

## Fuse curve 7.2 kV

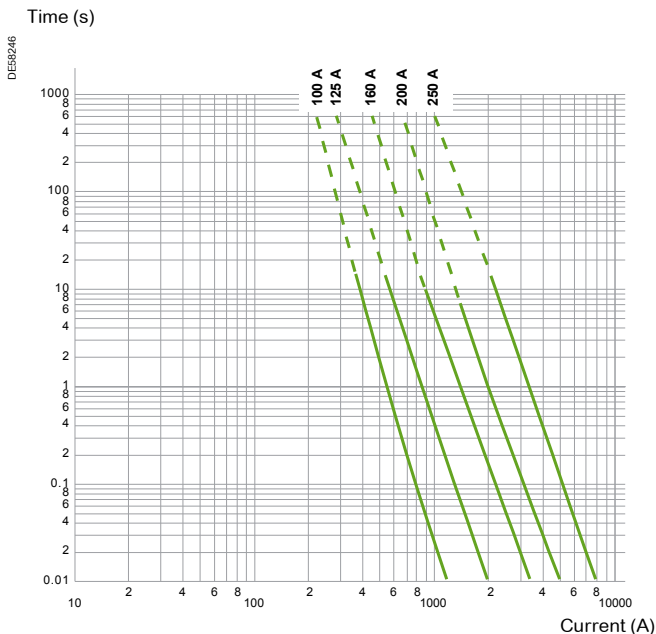

## Current limitation curve 7.2 kV

### Maximum value of cut-off current (kA peak)

The diagram shows the maximum limited broken current value as a function of the rms current value which could have occurred in the absence of a fuse.

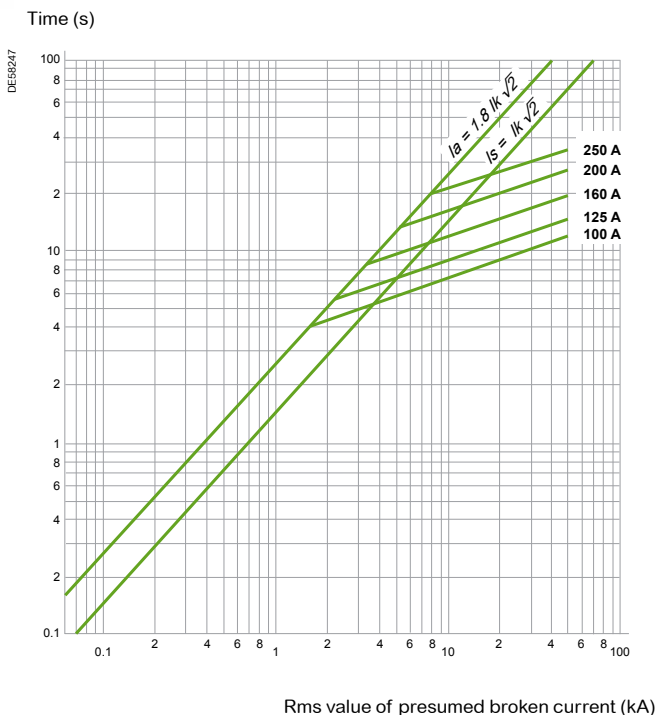





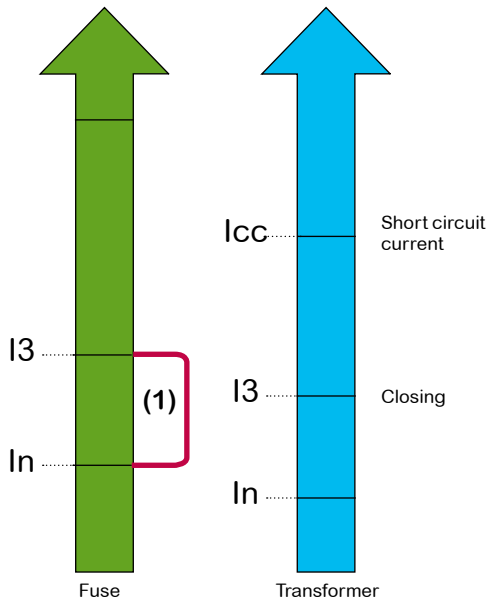

(1) In this current zone, any overloads must be eliminated by LV protection devices or by a MV switch equipped with an overcurrent relay.

## General

According to their specific characteristics, the various types of fuses (Fusarc CF, Soléfuse, Tépéfuse and MGK) provide real protection for a wide variety of medium and high voltage equipment (transformers, motors, capacitors). It is of the utmost importance to always remember the following points:  
 Un of the fuse must be greater than or equal to the network voltage  
 I1 of a fuse must be greater than or equal to the network short circuit current  
 The characteristics of the equipment to be protected must always be taken into consideration.

## Transformer protection

A transformer imposes three main stresses on a fuse. This is why the fuses must be capable of:

### ■ Withstanding the peak start-up current which accompanies transformer closing

The fuses' fusion current at 0.1 s must be more than 12 times the transformer's rated current.

$$I_f(0.1 \text{ s}) > 12 \times I_n \text{ transfo.}$$

### ■ Breaking fault currents across the terminals of the transformer secondary

A fuse intended to protect a transformer has to break its rated short circuit current ( $I_{sc}$ ) before it can damage the transformer.

$$I_{sc} > I_f(2 \text{ s})$$

### ■ Withstanding the continuous operating current together with possible overloads

In order to achieve this, the fuse's rated current must be over 1.4 times the transformer's rated current.

$$I_n \text{ fuse} > 1.4 I_n \text{ transfo.}$$

## Choice of rating

In order to correctly select the fuse's rated current to protect a transformer, we have to know and take account of:

### ■ The transformer characteristics:

- power (P in kVA)
- short circuit voltage ( $U_{sc}$  in %)
- rated current.

### ■ The fuse characteristics:

- time/current characteristics ( $I_f$  0.1 s and  $I_f$  2 s)
- the minimum rated breaking current ( $I_3$ ).

### ■ The installation and operating conditions:

- open air, cubicle or fuse chamber
- presence or otherwise of permanent overload
- short circuit current in the installation
- indoor or outdoor usage.

**Comment:** whether used in Schneider Electric's SM6, RM6, CAS 36 or in a device from another manufacturer, the equipment manufacturer's own user's instructions must be referred to when choosing the fuse.

### Fusarc CF fuses DIN standard for transformer protection (rating in A) <sup>(1)</sup> <sup>(2)</sup> <sup>(3)</sup>

Operating voltage (kV)	Rated voltage (kV)	Transformer power (kVA)																	
		25	50	75	100	125	160	200	250	315	400	500	630	800	1000	1250	1600	2000	
3	7.2	16	25	31.5	40	50	63	80	100	125	125	160	200	250					
		<b>20</b>	<b>31.5</b>	<b>40</b>	<b>50</b>	<b>63</b>	<b>80</b>	<b>100</b>	<b>125</b>	<b>125</b>	<b>160</b>	<b>200</b>	<b>250</b>						
5	7.2	16	25	31.5	40	50	63	80	100	125	125	160	200	250					
		<b>10</b>	<b>20</b>	<b>31.5</b>	<b>40</b>	<b>40</b>	<b>50</b>	<b>63</b>	<b>80</b>	<b>80</b>	<b>100</b>	<b>100</b>	<b>125</b>	<b>125</b>	<b>160</b>	<b>200</b>	<b>250</b>		
6	7.2	6.3	16	20	25	31.5	40	50	63	80	100	125	125	160	200	250			
		<b>10</b>	<b>20</b>	<b>25</b>	<b>31.5</b>	<b>40</b>	<b>50</b>	<b>50</b>	<b>63</b>	<b>80</b>	<b>80</b>	<b>100</b>	<b>100</b>	<b>125</b>	<b>125</b>	<b>160</b>	<b>200</b>	<b>250</b>	
6.6	7.2	6.3	16	20	25	31.5	40	50	63	80	100	125	125	160	200	250			
		<b>10</b>	<b>20</b>	<b>25</b>	<b>31.5</b>	<b>31.5</b>	<b>40</b>	<b>50</b>	<b>63</b>	<b>63</b>	<b>80</b>	<b>100</b>	<b>100</b>	<b>125</b>	<b>125</b>	<b>160</b>	<b>200</b>	<b>250</b>	
10	12	6.3	10	16	20	25	31.5	40	50	63	80	100	100	125	125	160	200	250	
		<b>6.3</b>	<b>10</b>	<b>16</b>	<b>20</b>	<b>25</b>	<b>31.5</b>	<b>40</b>	<b>40</b>	<b>50</b>	<b>63</b>	<b>80</b>	<b>80</b>	<b>80</b>	<b>100</b>	<b>125</b>	<b>125</b>	<b>160</b>	
11	12	6.3	10	16	20	25	31.5	40	50	63	80	100	100	125	125	160	200	250	
		<b>6.3</b>	<b>10</b>	<b>16</b>	<b>20</b>	<b>25</b>	<b>31.5</b>	<b>31.5</b>	<b>40</b>	<b>50</b>	<b>63</b>	<b>63</b>	<b>80</b>	<b>80</b>	<b>100</b>	<b>125</b>	<b>125</b>	<b>160</b>	
13.2	17.5	4	10	16	20	25	31.5	40	50	63	80	100	100	125	125	160	200	250	
		<b>4</b>	<b>10</b>	<b>16</b>	<b>20</b>	<b>20</b>	<b>25</b>	<b>31.5</b>	<b>31.5</b>	<b>40</b>	<b>50</b>	<b>63</b>	<b>63</b>	<b>80</b>	<b>80</b>	<b>100</b>	<b>100</b>		
13.8	17.5	4	10	16	20	25	31.5	40	50	63	80	100	100	125	125	160	200	250	
		<b>4</b>	<b>10</b>	<b>16</b>	<b>16</b>	<b>20</b>	<b>25</b>	<b>31.5</b>	<b>31.5</b>	<b>40</b>	<b>50</b>	<b>63</b>	<b>63</b>	<b>80</b>	<b>80</b>	<b>100</b>	<b>100</b>		
15	17.5	4	6.3	10	16	20	25	31.5	40	50	63	80	100	100	125	125	160	200	250
		<b>4</b>	<b>6.3</b>	<b>10</b>	<b>16</b>	<b>20</b>	<b>20</b>	<b>25</b>	<b>31.5</b>	<b>40</b>	<b>50</b>	<b>63</b>	<b>63</b>	<b>80</b>	<b>80</b>	<b>100</b>	<b>100</b>	<b>100</b>	
20	24	6.3	10	16	20	25	31.5	40	50	63	80	100	100	125	125	160	200	250	
		<b>6.3</b>	<b>10</b>	<b>10</b>	<b>16</b>	<b>20</b>	<b>20</b>	<b>25</b>	<b>31.5</b>	<b>40</b>	<b>40</b>	<b>50</b>	<b>63</b>	<b>63</b>	<b>80</b>	<b>80</b>	<b>100</b>	<b>100</b>	
22	24	6.3	6.3	10	16	20	25	31.5	40	50	63	80	100	100	125	125	160	200	250
		<b>6.3</b>	<b>6.3</b>	<b>10</b>	<b>16</b>	<b>16</b>	<b>20</b>	<b>25</b>	<b>31.5</b>	<b>40</b>	<b>40</b>	<b>50</b>	<b>50</b>	<b>63</b>	<b>63</b>	<b>80</b>	<b>80</b>	<b>100</b>	
25	36	4	6.3	10	16	20	25	31.5	40	50	63	80	100	100	125	125	160	200	250
		<b>4</b>	<b>6.3</b>	<b>10</b>	<b>10</b>	<b>16</b>	<b>20</b>	<b>20</b>	<b>25</b>	<b>31.5</b>	<b>40</b>	<b>50</b>	<b>50</b>	<b>63</b>	<b>63</b>	<b>80</b>	<b>80</b>	<b>100</b>	<b>100</b>
30	36	4	6.3	6.3	10	16	20	25	31.5	40	50	63	80	100	100	125	125	160	200
		<b>4</b>	<b>6.3</b>	<b>6.3</b>	<b>10</b>	<b>10</b>	<b>16</b>	<b>20</b>	<b>20</b>	<b>25</b>	<b>31.5</b>	<b>40</b>	<b>40</b>	<b>50</b>	<b>50</b>	<b>63</b>	<b>63</b>	<b>80</b>	<b>80</b>

### Soléfuse fuses UTE standard for transformer protection (rating in A) <sup>(1)</sup> <sup>(2)</sup> <sup>(3)</sup>

Operating voltage (kV)	Rated voltage (kV)	Transformer power (kVA)																
		25	50	100	125	160	200	250	315	400	500	630	800	1000	1250	1600		
3	7.2	<b>16</b>	<b>16</b>	<b>31.5</b>	<b>63</b>	<b>63</b>	<b>63</b>	<b>80</b>	<b>100</b>	<b>100</b>	<b>125</b>							
3.3	7.2	<b>16</b>	<b>16</b>	<b>31.5</b>	<b>31.5</b>	<b>63</b>	<b>63</b>	<b>80</b>	<b>80</b>	<b>100</b>	<b>125</b>							
4.16	7.2	<b>6.3</b>	<b>16</b>	<b>31.5</b>	<b>31.5</b>	<b>31.5</b>	<b>63</b>	<b>63</b>	<b>80</b>	<b>80</b>	<b>100</b>	<b>125</b>						
5.5	7.2	<b>6.3</b>	<b>16</b>	<b>16</b>	<b>31.5</b>	<b>31.5</b>	<b>31.5</b>	<b>63</b>	<b>63</b>	<b>63</b>	<b>80</b>	<b>100</b>	<b>125</b>					
6	7.2	<b>6.3</b>	<b>16</b>	<b>16</b>	<b>31.5</b>	<b>31.5</b>	<b>31.5</b>	<b>63</b>	<b>63</b>	<b>63</b>	<b>80</b>	<b>100</b>	<b>100</b>	<b>125</b>				
6.6	7.2	<b>6.3</b>	<b>16</b>	<b>16</b>	<b>16</b>	<b>31.5</b>	<b>31.5</b>	<b>31.5</b>	<b>63</b>	<b>63</b>	<b>80</b>	<b>80</b>	<b>100</b>	<b>125</b>				
10	12	<b>6.3</b>	<b>10</b>	<b>16</b>	<b>16</b>	<b>25</b>	<b>31.5</b>	<b>31.5</b>	<b>31.5</b>	<b>50</b>	<b>43</b>	<b>63</b>	<b>80</b>	<b>80</b>	<b>100</b>			
11	12	<b>6.3</b>	<b>6.3</b>	<b>10</b>	<b>16</b>	<b>16</b>	<b>25</b>	<b>31.5</b>	<b>31.5</b>	<b>31.5</b>	<b>43</b>	<b>50</b>	<b>63</b>	<b>80</b>	<b>100</b>			
13.8	17.5/24	<b>6.3</b>	<b>6.3</b>	<b>10</b>	<b>10</b>	<b>16</b>	<b>16</b>	<b>25</b>	<b>31.5</b>	<b>31.5</b>	<b>31.5</b>	<b>43</b>	<b>50</b>	<b>63</b>	<b>80</b>			
15	17.5/24	<b>6.3</b>	<b>6.3</b>	<b>10</b>	<b>10</b>	<b>16</b>	<b>16</b>	<b>25</b>	<b>31.5</b>	<b>31.5</b>	<b>31.5</b>	<b>43</b>	<b>50</b>	<b>63</b>	<b>80</b>	<b>80</b>		
20	24	<b>6.3</b>	<b>6.3</b>	<b>6.3</b>	<b>6.3</b>	<b>10</b>	<b>16</b>	<b>16</b>	<b>25</b>	<b>31.5</b>	<b>31.5</b>	<b>43</b>	<b>43</b>	<b>50</b>	<b>63</b>			
22	24	<b>6.3</b>	<b>6.3</b>	<b>6.3</b>	<b>6.3</b>	<b>10</b>	<b>10</b>	<b>16</b>	<b>16</b>	<b>25</b>	<b>25</b>	<b>31.5</b>	<b>31.5</b>	<b>43</b>	<b>43</b>	<b>63</b>		
30	36			<b>6.3</b>	<b>6.3</b>	<b>6.3</b>	<b>16</b>	<b>16</b>	<b>16</b>	<b>16</b>	<b>16</b>	<b>31.5</b>	<b>31.5</b>	<b>31.5</b>				

(1) Fuse ratings correspond to open air installation with a transformer overload of 30%, or to an indoor installation without transformer overload.  
(2) If the fuse is incorporated in a distribution switchboard, please refer to the selection table provided by the manufacturer of this device.  
(3) although the ratings shown in bold type are the most appropriate, the others also protect transformers in a satisfactory manner.

### Fusarc CF selection for motor protection

Table no. 8

Maximum operating voltage (kV)	Start-up current (A)	Start-up time (s)					
		5		10		20	
		Number of start-ups per hour					
		6	12	6	12	6	12
3.3	1410	250					
	1290	250	250	250			
	1140	250	250	250	250	250	250
	1030	250	250	250	250	250	250
	890	250	250	250	250	250	250
	790	200	250	250	250	250	250
	710	200	200	200	250	250	250
	640	200	200	200	200	200	250
6.6	610	200	200	200	200	200	200
	540	160	160	160	200	200	200
	480	160	160	160	200	200	200
	440	160	160	160	160	160	200
	310	160	160	160	160	160	160
	280	125	160	160	160	160	160
	250	125	125	125	160	160	160
	240	125	125	125	125	125	160
	230	125	125	125	125	125	125
	210	100	125	125	125	125	125
	180	100	100	100	100	100	125
	170	100	100	100	100	100	100
11	160	100	100	100	100	100	100
	148	80	100	100	100	100	100
	133	80	80	80	100	100	100
	120	80	80	80	80	80	100
	110	80	80	80	80	80	80
	98	63	80	80	80	80	80
	88	63	63	63	63	80	80
	83	63	63	63	63	63	80
	73	50	63	63	63	63	63
	67	50	50	50	63	63	63
	62	50	50	50	50	50	63
57	50	50	50	50	50	50	

### Motor protection

When combined with a contactor, fuses provide a particularly effective protection system for an MV motor.

The specific stresses that fuses have to withstand are due to:

- The motor to be protected
- The network on which it is placed.

#### Stresses due to the motor

- The start-up current ( $I_d$ ).
- The start-up duration ( $T_d$ ).
- The number of successive start-ups.
- When the motor is energised, and throughout the start-up period, the impedance of a motor is such that it consumes a current  $I_d$  which is significantly greater than the rated load current  $I_n$ . Normally, this current  $I_d$  is around 6 times the rated current, ( $I_d/I_n = 6$ ).
- The start-up duration  $T_d$  depends on the type of load that is being driven by the motor. It is of around ten seconds.
- We also have to take account of the possibility of several successive start-ups in choosing the fuse rating.

#### Stresses related to the network

- The rated voltage: the rated voltage for MV motors is at most equal to 11 kV.
- The limited broken current: networks with MV motors are generally high installed power networks with very high short circuit currents.

#### Choice of rating

The fuse rating chosen depends on three parameters:

- The start-up current
- The duration
- The start-up frequency

$\eta$  = motor efficiency

$U_a$  = rated motor voltage

$I_d$  = start up current

$T_d$  = start up time

The three charts given below enable the fuse rating to be determined when we know the motor power (P in kW) and its rated voltage ( $U_a$  in kV).

**Chart 1:** this gives the rated current  $I_n$  (A) according to P and  $U_a$ .

**Chart 2:** this gives the start-up current  $I_d$  (A) according to  $I_n$  (A).

**Chart 3:** this gives the appropriate rating according  $I_d$  and the start-up duration time  $t_d$  (s).

### Comments

Chart 1 is plotted for a power factor of 0.92 and an efficiency of 0.94.

For values different to this, use the following equation:  $I_n = \frac{P}{n \sqrt{3} U_a \cdot \text{p.f.}}$

■ chart 3 is given in the case of 6 start-ups spread over an hour or 2 successive startups.

■ For n successive start-ups ( $n > 6$ ), multiply  $t_d$  by  $\frac{n}{6}$

For p successive start-ups ( $p > 2$ ), multiply  $t_d$  by  $\frac{p}{2}$  (see selection table)  
In the absence of any information, take  $t_d = 10$  s.

■ if the motor start-up is not direct, the rating obtained using the charts below may be less than the full load current of the motor. In this case, we have to choose a rating 20% over the value of this current, to take account of the cubicle installation.

Fuses with a rating chosen using these charts will satisfy fuse ageing tests according to recommendations in IEC 60644.

### Example (in blue in the charts)

A 1650 kW motor powered at 6.6 kV (point A, chart 1) has a current of 167 A (point B).

The start-up current, 6 times greater than the rated current = 1000 A (point C, chart 2).

For a start-up time of 10 s, chart 3 shows a rating of 250 A (point D).

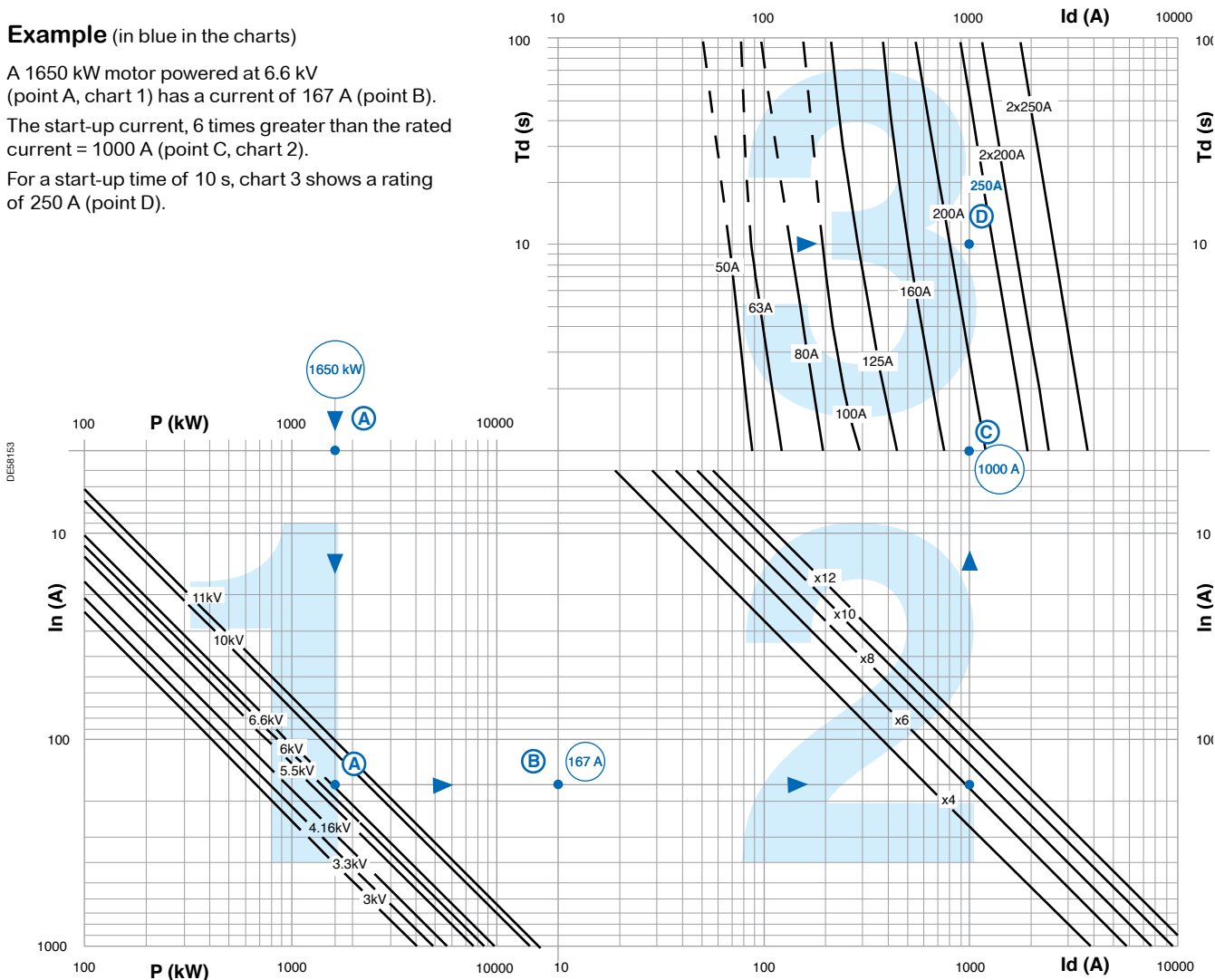

---

Fuses intended to protect capacitor banks have to withstand special voltages:

- When the bank is energised, the inrush current is very high and can lead to premature ageing or fusion of the fuse element
- In service, the presence of harmonics can lead to excessive temperature rise.

### Choice of rating

A common rule applied to any switchgear in the presence of capacitor banks is to derate the rated current by 30 to 40% due to the harmonics which cause additional temperature rise.

It is recommended to apply a coefficient of between 1.7 and 1.9 to the capacitive current in order to obtain the appropriate fuse rating, i.e. 1.7 or 1.9 times the rated current of the bank.

As for transformers, it is necessary to know the rms inrush current value and its duration.

# Comments on substituting fuses

---

In accordance with recommendation in IEC 60282-1 (Application guide):  
« it is recommended to replace all three fuses in a three-phase circuit when one of them has already blown, unless we are certain that there has been no overcurrent in the fuses which have not blown ».

Moreover, in this guide, we can find several basic recommendations for the correct use of this type of fuse.

It is important to take account of the fact that the striker only acts when all of the fuse elements have blown. However, if the striker has not been activated, this does not mean that the fuses have not been subject to an overcurrent.





PM104192



PM104193

### Individual packaging

Fuses are packed individually

PM104194



### Solefuse packaging

3 unit per carton.

- Dimensions: 55 x 22 x 8 cm

PM104195



### Rest of Fuses

Depending on the type of fuse specified and the quantity ordered packaging may vary.

#### Ground Shipping

- Carton packaging with wooden pallet.
- Dimensions:
  - 66 x 38 x 42 cm
  - 120 x 80 x 40 cm
  - 120 x 80 x 70 cm

#### Export Shipping

- Wooden packaging box
- Wooden packaging box with wooden pallet.  
The edges of the case are reinforced by metal.
- Dimensions:
  - 64 x 32 x 42 cm
  - 120 x 80 x 40 cm
  - 120 x 80 x 70 cm